

175, 177, 179

True-rms Multimeters

Calibration Information

Introduction

Warning

To avoid electric shock or injury, do not perform the performance tests or calibration adjustment procedures unless qualified to do so.

The information provided in this document is for the use of qualified personnel only.

The *175, 177, 179 Calibration Information* provides the information necessary to adjust and verify the performance of the 175, 177, and 179 True-rms Multimeters (hereafter known as the Product).

The following information is included in this document:

- Safety Information and International Electrical Symbols
- Test Lead Alert
- Specifications
- Testing and Replacing the Fuses
- Replacing the Battery
- Cleaning
- Replacing the LCD
- Performance Tests
- Calibration Adjustment
- User-Replaceable Parts and Accessories
- Complete Warranty

See the *175, 177, 179 Users Manual* for complete operating instructions.

How to Contact Fluke

To contact Fluke, call one of the following telephone numbers:

- Technical Support USA: 1-800-44-FLUKE (1-800-443-5853)
- Calibration/Repair USA: 1-888-99-FLUKE (1-888-993-5853)
- Canada: 1-800-36-FLUKE (1-800-363-5853)
- Europe: +31-402-675-200
- Japan: +81-3-6714-3114
- Russia: +8-495-664-75-12
- Singapore: +65-6799-5566
- Anywhere in the world: +1-425-446-5500

Or, visit Fluke's website at www.fluke.com.

To register your product, visit <http://register.fluke.com>.

To view, print, or download the latest manual supplement, visit <http://us.fluke.com/user/support/manuals>.

Safety Information

In this manual, a **Warning** identifies conditions and procedures that are dangerous to the user. A **Caution** identifies conditions and procedures that can cause damage to the Product or the equipment under test.

⚠⚠ Warning

To prevent possible electrical shock, fire, or personal injury:





















- Read all safety information before you use the Product.
- Carefully read all instructions.
- Use the Product only as specified, or the protection supplied by the Product can be compromised.
- Examine the case before you use the Product. Look for cracks or missing plastic. Carefully look at the insulation around the terminals.
- Do not use the Product around explosive gas, vapor, or in damp or wet environments.
- Do not work alone.
- Limit operation to the specified measurement category, voltage, or amperage ratings.
- Comply with local and national safety codes. Use personal protective equipment (approved rubber gloves, face protection, and flame-resistant clothes) to prevent shock and arc blast injury where hazardous live conductors are exposed.
- Use Product-approved measurement category (CAT), voltage, and amperage rated accessories (probes, test leads, and adapters) for all measurements.
- Do not exceed the Measurement Category (CAT) rating of the lowest rated individual component of a Product, probe, or accessory.
- Do not touch voltages >30 V ac rms, 42 V ac peak, or 60 V dc.
- Keep fingers behind the finger guards on the probes.
- Use only current probes, test leads, and adapters supplied with the Product.
- Connect the common test lead before the live test lead and remove the live test lead before the common test lead.
- Disable the Product if it is damaged.
- Do not use the Product if it is damaged.
- Do not use the Product if it operates incorrectly.
- Only use probes, test leads, and accessories that have the same measurement category, voltage, and amperage ratings as the Product.
- Remove the batteries if the Product is not used for an extended period of time, or if stored in temperatures above 50 °C. If the batteries are not removed, battery leakage can damage the Product.
- The battery door must be closed and locked before you operate the Product.
- Use only cables with correct voltage ratings.
- Remove all probes, test leads, and accessories before the battery door is opened.

- Replace the batteries when the low battery indicator shows to prevent incorrect measurements.
- Do not apply more than the rated voltage, between the terminals or between each terminal and earth ground.
- Measure a known voltage first to make sure that the Product operates correctly.
- Use the correct terminals, function, and range for measurements.
- Do not use test leads if they are damaged. Examine the test leads for damaged insulation, exposed metal, or if the wear indicator shows. Check test lead continuity.
- Do not touch the probes to a voltage source when the test leads are connected to the current terminals.
- Do not use test leads if they are damaged. Examine the test leads for damaged insulation and measure a known voltage.
- Do not use in CAT III or CAT IV environments without the protective cap installed on test probe. The protective cap decreases the exposed probe metal to <4 mm. This decreases the possibility of arc flash from short circuits.

Symbols

Table 1 is a list of the symbols used on the Product and in this manual.

Table 1. Symbols

Symbol	Description	Symbol	Description
	Consult user documentation.		Earth
	WARNING. RISK OF DANGER.		Capacitance
	WARNING. HAZARDOUS VOLTAGE. Risk of electric shock.		Fuse
	Earth		Conforms to European Union directives.
	AC (Alternating Current)		Double Insulated
	DC (Direct Current)		Low battery. Replace battery.
	Both direct and alternating current		Minimum fuse interrupt rating.
	Continuity test or continuity beeper tone.		Certified by TÜV SÜD Product Service.
	Conforms to European Union directives.		Conforms to relevant Australian Safety and EMC standards.
	Certified by CSA Group to North American safety standards.		Conforms to relevant South Korean EMC Standards.
CAT II	Measurement Category II is applicable to test and measuring circuits connected directly to utilization points (socket outlets and similar points) of the low-voltage MAINS installation.		
CAT III	Measurement Category III is applicable to test and measuring circuits connected to the distribution part of the building's low-voltage MAINS installation.		
CAT IV	Measurement Category IV is applicable to test and measuring circuits connected at the source of the building's low-voltage MAINS installation.		
	This product complies with the WEEE Directive marking requirements. The affixed label indicates that you must not discard this electrical/electronic product in domestic household waste. Product Category: With reference to the equipment types in the WEEE Directive Annex I, this product is classed as category 9 "Monitoring and Control Instrumentation" product. Do not dispose of this product as unsorted municipal waste.		

Test Lead Alert

To remind you to check that the test leads are in the correct terminals, LEAd momentarily shows on the display when you move the rotary switch to or from the mA or A position.

Warning

Attempting to make a measurement with a test lead in an incorrect terminal might blow a fuse, damage the Product, and cause serious personal injury.

Specifications

Accuracy is specified for 1 yr after calibration, at operating temperatures of 18 °C to 28 °C, with relative humidity at 0 % to 90 %. Accuracy specifications take the form of: \pm ([% of Reading] + [Counts])

Maximum voltage between any terminal and earth ground	1000 V
⚠ Fuse Protection for mA inputs	0.44 A, 1000 V, IR 10 kA
⚠ Fuse Protection for A input	11 A, 1000 V, IR 17 kA
Display	Digital: 6000 counts, updates 4/sec
Bar Graph	33 segments, Updates 40x/sec
Frequency	10 000 counts
Capacitance	1000 counts
Altitude	
Operating	2000 m
Storage	12 000 m
Temperature	
Operating	-10 °C to +50 °C
Storage	-40 °C to +60 °C
Temperature coefficient	0.1 X (specified accuracy / °C, (<18 °C or >28 °C))
Relative Humidity	Maximum Non-condensing: 90 % to 35 °C, 75 % to 40 °C, 45 % to 50 °C
Battery Life	Alkaline: 400 hrs typical
Size (H x W x L)	4.3 cm x 9 cm x 18.5 cm
Weight	420 g
Safety	
General	IEC 61010-1: Pollution Degree 2
Measurement	IEC 61010-2-033: CAT IV 600 V, CAT III 1000 V
Electromagnetic Compatibility (EMC)	
International	IEC 61326-1: Portable Electromagnetic Environment CISPR 11: Group 1, Class A, IEC 61326-2-2
<i>Group 1: Equipment has intentionally generated and/or uses conductively-coupled radio frequency energy that is necessary for the internal function of the equipment itself.</i>	
<i>Class A: Equipment is suitable for use in all establishments other than domestic and those directly connected to a low-voltage power supply network that supplies buildings used for domestic purposes. There may be potential difficulties in ensuring electromagnetic compatibility in other environments due to conducted and radiated disturbances.</i>	
<i>Emissions that exceed the levels required by CISPR 11 can occur when the equipment is connected to a test object. The equipment may not meet the immunity requirements of this standard when test leads and/or test probes are connected.</i>	
Korea (KCC)	Class A Equipment (Industrial Broadcasting & Communication Equipment)
<i>Class A: Equipment meets requirements for industrial electromagnetic wave equipment and the seller or user should take notice of it. This equipment is intended for use in business environments and not to be used in homes.</i>	
USA (FCC)	47 CFR 15 subpart B. This product is considered an exempt device per clause 15.103.

Electrical Specifications

Function	Range ^[1]	Resolution	Accuracy ±([% of Reading] + [Counts])				
			175	177	179		
AC Volts ^{[2][3]}	600.0 mV 6.000 V 60.00 V 600.0 V 1000 V	0.1 mV 0.001 V 0.01 V 0.1 V 1 V	1.0 % + 3 (45 Hz to 500 Hz)	1.0 % + 3 (45 Hz to 500 Hz)	1.0 % + 3 (45 Hz to 500 Hz)		
			2.0 % + 3 (500 Hz to 1 kHz)	2.0 % + 3 (500 Hz to 1 kHz)	2.0 % + 3 (500 Hz to 1 kHz)		
DC mV	600.0 mV	0.1 mV	0.15 % + 2	0.09 % + 2	0.09 % + 2		
DC Volts	6.000 V 60.00 V 600.0 V	0.001 V 0.01 V 0.1 V	0.15 % + 2	0.09 % + 2	0.09 % + 2		
	1000 V	1 V	0.15 % + 2	0.15 % + 2	0.15 % + 2		
Continuity	600 Ω	1 Ω	Product beeps at <25 Ω, beeper turns off at >250 Ω; detects opens or shorts of 250 μs or longer.				
Ohms	600.0 Ω	0.1 Ω	0.9 % + 2	0.9 % + 2	0.9 % + 2		
	6.000 kΩ	0.001 kΩ	0.9 % + 1	0.9 % + 1	0.9 % + 1		
	60.00 kΩ	0.01 kΩ	0.9 % + 1	0.9 % + 1	0.9 % + 1		
	600.0 kΩ	0.1 kΩ	0.9 % + 1	0.9 % + 1	0.9 % + 1		
	6.000 MΩ	0.001 MΩ	0.9 % + 1	0.9 % + 1	0.9 % + 1		
	50.00 MΩ	0.01 MΩ	1.5 % + 3	1.5 % + 3	1.5 % + 3		
Diode test	2.400 V	0.001 V	1 % + 2				
Capacitance	1000 nF	1 nF	1.2 % + 2	1.2 % + 2	1.2 % + 2		
	10.00 μF	0.01 μF	1.2 % + 2	1.2 % + 2	1.2 % + 2		
	100.0 μF	0.1 μF	1.2 % + 2	1.2 % + 2	1.2 % + 2		
	9999 μF ^[4]	1 μF	10 % typical	10 % typical	10 % typical		
AC Amps ^[5] (True -rms) (45 Hz to 1 kHz)	60.00 mA 400.0 mA ^[6] 6.000 A 10.00 A ^[7]	0.01 mA 0.1 mA 0.001 A 0.01 A	1.5 % + 3	1.5 % + 3	1.5 % + 3		
	DC Amps ^[5]	60.00 mA 400.0 mA ^[6] 6.000 A 10.00 A ^[7]	0.01 mA 0.1 mA 0.001 A 0.01 A	1.0 % + 3	1.0 % + 3	1.0 % + 3	
		Hz (AC- or DC- coupled, V or A ^{[8][9]} input)	99.99 Hz 999.9 Hz 9.999 kHz 99.99 kHz	0.01 Hz 0.1 Hz 0.001 kHz 0.01 kHz	0.1 % + 1	0.1 % + 1	0.1 % + 1
			Temperature ^[10]	-40 °C to +400 °C -40 °F to +752 °F	0.1 °C 0.1 °F	NA	NA
MIN MAX AVG				For dc functions, accuracy is the specified accuracy of the measurement function ±12 counts for changes longer than 350 ms in duration. For ac functions, accuracy is the specified accuracy of the measurement function ±40 counts for changes longer than 900 ms in duration.			

[1] All ac voltage and ac current ranges are specified from 5 % of range to 100 % of range.
[2] Crest factor of ≤3 at full scale up to 500 V, decreasing linearly to crest factor ≤1.5 at 1000 V.
[3] For non-sinusoidal waveforms, add -(2 % reading + 2 % full scale) typical, for crest factors up to 3.
[4] In the 9999 μF range for measurements to 1000 μF, the measurement accuracy is 1.2 % + 2 for all models.
[5] Amps input burden voltage (typical): 400 mA input 2 mV/mA, 10 A input 37 mV/A.
[6] 400.0 mA accuracy specified up to 600 mA overload.
[7] >10 A unspecified.
[8] Frequency is specified from 2 Hz to 99.99 kHz in Volts and from 2 Hz to 30 kHz in Amps.
[9] Below 2 Hz, the display shows zero Hz.
[10] In RF field of 3 V/m specified accuracy ±5 °C (9 °F).
[11] Does not include error of the thermocouple probe.

Function	Overload Protection ^[1]	Input Impedance (Nominal)	Common Mode Rejection Ratio (1 kΩ Unbalanced)	Normal Mode Rejection	
Volts ac	1000 V rms	>10 MΩ < 100 pF	> 60 dB @ dc, 50 Hz or 60 Hz		
Volts dc	1000 V rms	>10 MΩ < 100 pF	>120 dB @ dc, 50 Hz or 60 Hz	> 60 dB @ 50 Hz or 60 Hz	
mV/Ω	1000 V rms ^[2]	>10 MΩ < 100 pF	>120 dB @ dc, 50 Hz or 60 Hz	> 60 dB @ 50 Hz or 60 Hz	
		Open Circuit Test Voltage	Full Scale Voltage To:		Short Circuit Current
			600 kΩ	50 MΩ	
Ohms/Capacitance	1000 V rms ^[2]	<8.0 V dc	<660 mV dc	<4.6 V dc	<1.1 mA
Continuity/Diode test	1000 V rms ^[2]	<8.0 V dc	2.4 V dc		<1.1 mA

[1] 10⁷ V-Hz maximum.
[2] For circuits <0.3 A short circuit. 660 V for high energy circuits.

Function	Overload Protection	Overload
mA	Fused, 44/100 A, 1000 V FAST Fuse	600 mA overload for 2 minutes maximum, 10 minutes rest minimum
A	Fused, 11 A, 1000 V FAST Fuse	20 A overload for 30 seconds maximum, 10 minutes rest minimum

Frequency Counter Sensitivity						
Input Range ^{[1][2]}		Typical Sensitivity (RMS Sine Wave)				
		2 Hz to 45 Hz	45 Hz to 10 kHz	10 kHz to 20 kHz	20 kHz to 50 kHz	50 kHz to 100 kHz
Volts ac	600 mV	Unspecified ^[3]	80 mV	150 mV	400 mV	Unspecified ^[3]
	6 V	0.5 V	0.6 V	1.0 V	2.8 V	Unspecified ^[3]
	60 V	5 V	3.8 V	4.1 V	5.6 V	9.6 V
	600 V	50 V	36 V	39 V	45 V	58 V
	1000 V	500 V	300 V	320 V	380 V	NA
Volts dc	6 V	0.5 V	0.75 V	1.4 V	4.0 V	Unspecified ^[3]
	60 V	4 V	3.8 V	4.3 V	6.6 V	13 V
	600 V	40 V	36 V	39 V	45 V	58 V
	1000 V	500 V	300 V	320 V	380 V	NA
AC/DC Amps	mA	5 mA	4 mA	4 mA	4 mA ^[4]	NA
	A	0.5 A	0.4 A	0.4 A	0.4 A ^[4]	NA

[1] Maximum input for specified accuracy = 10X Range or 1000 V.
[2] Noise at low frequency and amplitude may exceed the frequency accuracy specification.
[3] Unspecified but usable depending on quality and amplitude of signal.
[4] In mA and A ranges, frequency measurement is specified to 30 kHz.

Test the Fuses

To test the fuses (see Figure 1):

- Set the Rotary Switch to Ω.
- Plug a test lead into the **VΩ** terminal and touch the probe to the **400 mA** (to test the 440 mA Fuse) or **10 A** terminal (to test the 11 A Fuse).
 - If the display shows a resistance value in the range shown in Figure 1, the fuse is good.
 - If the display reads Ω, replace the fuse and test again.
 - If the display shows any other value, have the Product serviced. See *How to Contact Fluke* earlier in this manual.

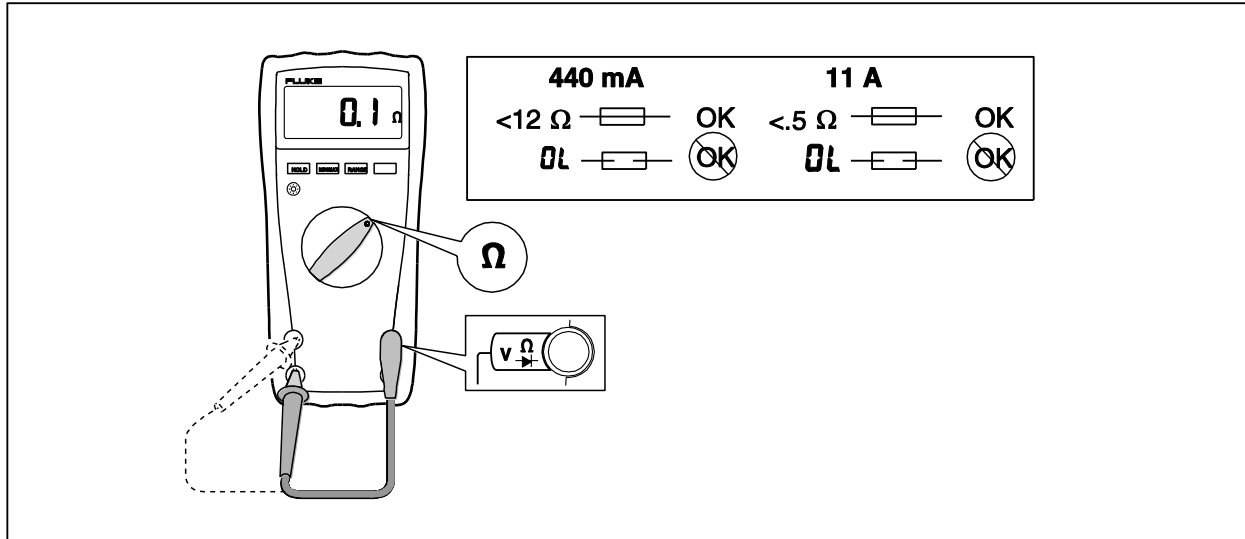

Figure 1. Test the Current Fuses

aik12f.eps

Replace the Fuses

⚠⚠ Warning

To prevent possible electrical shock, fire, personal injury, or damage to the Product:

- Remove the test leads and any input signals before replacing the fuse.
- Use **ONLY** fuses with the amperage, interrupt, voltage, and speed ratings specified.

To replace the Fuses (see Figure 2):

1. Turn the Rotary Switch to **OFF**.
2. Disconnect the test leads and/or any connectors from the terminals.
3. Remove the four screws from the Case Bottom and separate the Case Top from the Case Bottom.
4. Remove the fuses by gently prying one end loose, then slide the fuse out of its bracket, and replace with a properly rated good fuse.
5. Rejoin the Case Bottom and Case Top, and reinstall the four screws.

Replace the Battery

⚠⚠ Warning

To prevent possible electrical shock, fire, personal injury, or damage to the Product, replace the battery as soon as the low battery indicator (🔋) appears.

To replace the Battery (see Figure 2):

1. Turn the Rotary Switch to OFF and remove the test leads from the terminals.
2. Remove the two screws from the Battery Compartment Door, and remove it from the Case Bottom.
3. Remove the Battery from the battery connector.
4. Replace the Battery with a new 9 V battery (NEDA A1604, 6F22, or 006P).
5. Reattach the Battery Compartment Door to the Case Bottom and reinstall the two screws.

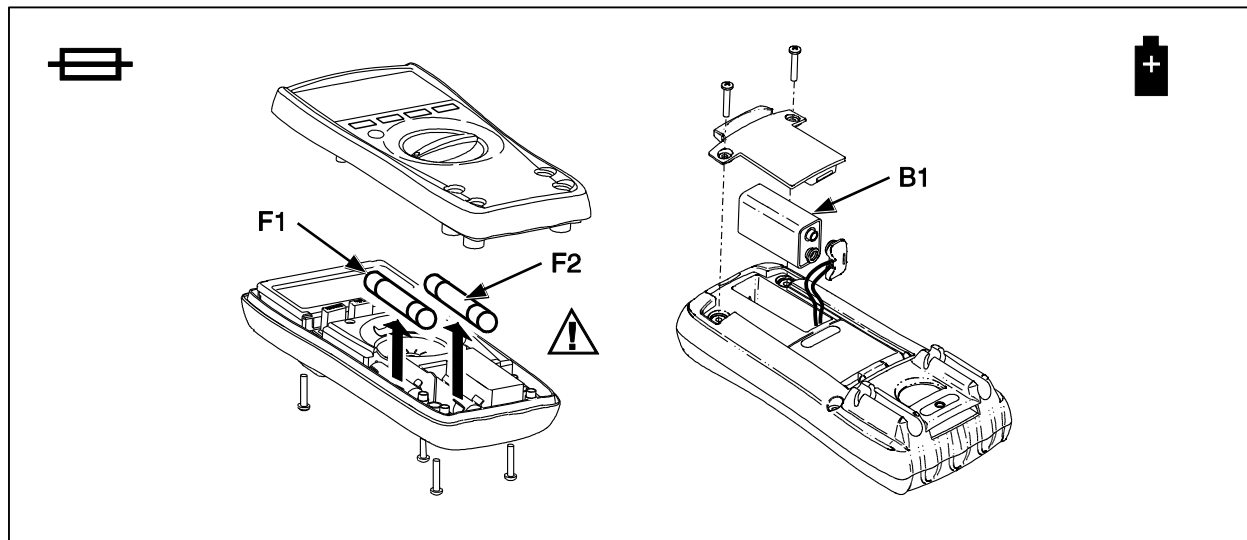

Figure 2. Battery and Fuse Replacement

aik13f.eps

Maintenance

⚠⚠ Warning

To prevent possible electrical shock, fire, personal injury, or damage to the Product:

- Repair the Product before use if the battery leaks.
- Do not operate the Product with covers removed or the case open. Hazardous voltage exposure is possible.
- Remove the input signals before you clean the Product.
- Use only specified replacement parts.
- Have an approved technician repair the Product.
- Use only specified replacement fuses.
- Replace a blown fuse with exact replacement only for continued protection against arc flash.

Clean the Product

⚠⚠ Warning

To avoid electrical shock:

- Remove test leads and any input signals before cleaning.
- Do not reinstall the pca until it is completely dry.

Dirt or moisture in the terminals can affect readings.

⚠ Caution

To avoid damaging the Product:

- Do not use aromatic hydrocarbons or chlorinated solvents for cleaning. These solutions will react with the plastics used in the instruments.
- Do not use detergents of any kind for cleaning the pca.

Clean the instrument case with a damp cloth and mild detergent.

The pca may be washed with isopropyl alcohol or hot deionized water and a soft brush. Remove excess cleaning material with clean dry air at low pressure, then dry the pca at 50 °C.

Replace the LCD

⚠ Caution

To prevent contamination, do not handle the conductive edges of the LCD or the LCD Elastomeric Connectors.

If the edges are contaminated, clean them with alcohol. Allow the alcohol to dry before reassembling.

To remove and replace the LCD, perform the following procedure (refer to Figure 3):

1. Turn the Rotary Switch to **OFF** and remove the test leads from the Product terminals.
2. Remove the four screws from the Case Bottom, and separate the Case Top from the Case Bottom. The circuit board remains attached to the Case Bottom.
3. Remove battery compartment door and disconnect the battery from the battery connector.
4. Remove the PCA Screw located under the 440 mA Fuse, and lift the pca out of the Case Bottom. The beeper is loose in the bottom case. Exercise caution not to damage it.
5. Loosen the 4 screws on the back of the pca. This will facilitate reinstalling the LCD.
6. Insert a small, flat-head screwdriver under the LCD Mask edge and gently pry the LCD Mask from the snaps.

⚠ Caution

Take care to not break the LCD with the screwdriver.

7. Lift out the LCD.
8. Make sure that all connector contact points are clean. Refer to *Clean the Product* for more information.
9. Install a new LCD, taking care that it is correctly oriented.
10. Reattach the LCD Mask to the LCD assembly by snapping the LCD Mask into place.
11. Tighten the 4 screws on the back of the pca.
12. Lay the pca back into the Case Bottom, and screw it down.
13. Reinsert the 440 mA Fuse.
14. Reinstall the Battery.
15. Rejoin the Case Bottom, Case Top, battery compartment door and reinstall the four case screws.

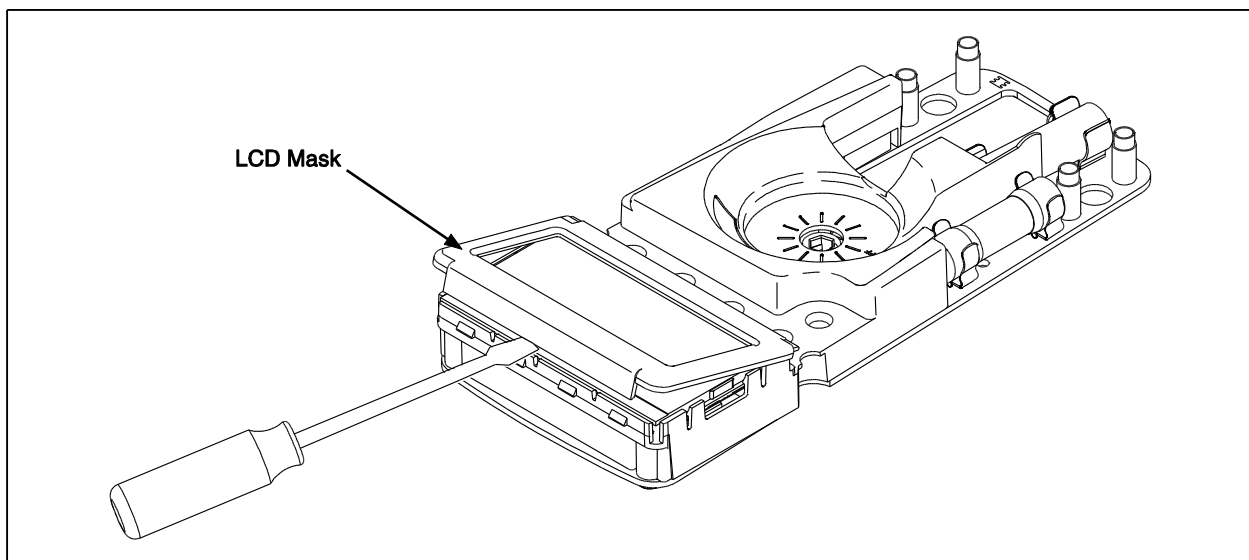

Figure 3. Remove the LCD Mask

Performance Tests

Warning

To avoid electric shock, do not perform the performance test procedures unless the Product is fully assembled.

The following performance tests verify the complete operation of the Product and check the accuracy of each Product function against its specifications. If the Product fails any part of the test, calibration adjustment and/or repair is indicated.

In the performance tests, the Product is referred to as the unit under test (UUT).

Required Equipment

A Fluke 5500A Multi-Product Calibrator (or equivalent) is required for the performance test procedures in this document.

If an equivalent calibrator is used, it must meet the accuracy specifications shown in Table 2.

Table 2. Calibrator Specifications

Recommended Equipment	Measurement Function	Accuracy
5500A Multi-Product Calibrator (or equivalent)	DC Volts	30 mV to 1000 V ± 0.0225 %
	DC Current	3 mA to 9 A ± 0.25 %
	AC Volts	300 mV to 1000 V ± 0.25 % @ 45 Hz to 1 kHz
	AC Current	3 mA to 9 A ± 0.375 % @ 45 Hz to 1 kHz
	Resistance	25 Ω to 500 Ω ± 0.225 % 19 M Ω ± 0.4 %
	Capacitance	900 nF ± 0.30 %
	Temperature	-40 to 400 $^{\circ}$ C 0.25 %
	Frequency	5 V, 50 kHz ± 0.025 %
Fluke 80 AK K-type Thermocouple Adapter Accessory	Temperature	-
K-type Thermocouple, mini-plug on both ends	Temperature	-

Prepare for the Performance Test

Warning

To avoid possible electric shock or personal injury:

- **Do not perform the following procedures unless qualified to do so. Some procedures involve the use of high voltages.**
- **Before handling the test connections and in between tests, make sure the calibrator is in standby mode (STBY).**

To prepare for the performance test:

1. Make sure that you have the required equipment (see Table 2).
2. Warm up the calibrator as required by its specifications.
3. Allow the temperature of the UUT to stabilize at room temperature (23 $^{\circ}$ C \pm 5 $^{\circ}$ C [73 $^{\circ}$ F \pm 9 $^{\circ}$ F]).
4. Check the fuses and Battery, and replace them if necessary. Refer to *Test the Fuses, Replace the Fuses*, and *Replace the Battery*.

Performance Tests

Note

When calibrating or measuring AC current, avoid the potential for errors from coupled noise, by either:

1. Shorting the $V\Omega\rightarrow$ to the **COM** input
or

2. Having **NO** connection to the $V\Omega\rightarrow$ input.

1. Set the UUT Rotary Switch to the position called for in Table 2 (175) or Table 3 (177/179), and for all measurements other than current (amps), connect the calibrator to the $V\Omega\rightarrow$ and **COM** input terminals.

- If testing the milliamps function, connect the calibrator to the **400 mA** and **COM** input terminals on the Product.
- If testing the amps function, connect the calibrator to the **10A** and **COM** input terminals on the Product.









2. Apply the indicated calibrator output voltages to the UUT for each test (see Table 3 or Table 4).

3. Verify that the UUT displays a reading that is within the limits shown in the Product Response column.

Table 3. Performance Tests 175

Test (Switch Position)	5500 Output	Product Response	
		Lower Limit	Upper Limit
\tilde{V} AC Volts	300 mV 45 Hz	296.7 mV ac	303.3 mV ac
	500 mV 500 Hz	494.7 mV ac	505.3 mV ac
	500 mV 1 kHz	489.7 mV ac	510.3 mV ac
	5 V 45 Hz	4.947 V ac	5.103 V ac
	5 V 500 Hz	4.947 V ac	5.053 V ac
	5 V 1 kHz	4.897 V ac	5.103 V ac
	50 V 45 Hz	49.47 V ac	50.53 V ac
	50 V 500 Hz	49.47 V ac	50.53 V ac
	50 V 1 kHz	48.97 V ac	51.03 V ac
	300 V 45 Hz	296.7 V ac	303.3 V ac
	500 V 500 Hz	494.7 V ac	505.3 V ac
	500 V 1 kHz	489.7 V ac	510.3 V ac
	1000 V 45 Hz	987 V ac	1013 V ac
	1000 V 500 Hz	987 V ac	1013 V ac
	1000 V 1 kHz	977 V ac	1023 V ac
\tilde{V} Hz AC Volts Frequency ^[1]	1 V 45 Hz	44.94 Hz	45.06 Hz
	1 V 900 Hz	899 Hz	901 Hz
	1 V 9 kHz	8.99 kHz	9.01 kHz
	5 V 50 kHz	49.94 kHz	50.06 kHz
\bar{V} DC Volts	5 V	4.990 V dc	5.010 V dc
	50 V	49.90 V dc	50.1 V dc
	300 V	299.3 V dc	300.7 V dc
	1000 V	996 V dc	1004 V dc
	-1000 V	-1004 V dc	-996 V dc
\bar{V} Hz DC Volts Frequency ^[1]	3 V 45 Hz	44.94 Hz	45.06 Hz
	30 V 50 kHz	49.94 kHz	50.06 kHz

Table 3. Performance Tests 175 (continued)









Test (Switch Position)	5500 Output	Product Response	
		Lower Limit	Upper Limit
 DC Millivolts	30 mV	29.8 mV dc	30.2 mV dc
	-300 mV	-300.7 mV dc	-299.3 mV dc
	600 mV	598.9 mV dc	601.1 mV dc
 Ohms ^[2]	500 Ω	495.3 Ω	504.7 Ω
	5 kΩ	4.954 kΩ	5.046 kΩ
	50 kΩ	49.54 kΩ	50.46 kΩ
	500 kΩ	495.4 kΩ	504.6 kΩ
	5 MΩ	4.954 MΩ	5.046 MΩ
	19 MΩ	18.68 MΩ	19.32 MΩ
 Capacitance ^[1]	Apply 0.90 μF	887 nF	913 nF
	Apply 9 μF	8.87 μF	9.13 μF
	Apply 90 μF	88.7 μF	91.3 μF
	Apply 900 μF	887 μF	913 μF
 Continuity	25 Ω	Beeper On	
	250 Ω	Beeper Off	
 Diode ^[1]	Apply 2.0 V	1.978 V dc	2.022 V dc
 AC Milliamps	3 mA 45 Hz	2.92 mA ac	3.08 mA ac
	50 mA 1 kHz	49.22 mA ac	50.78 mA ac
	400 mA 1 kHz	393.7 mA ac	406.3 mA ac
 AC Amps	4.0 A 45 Hz	3.937 A ac	4.063 A ac
	9.0 A 1 kHz	8.83 A ac	9.17 A ac
 DC Milliamp ^[1]	3 mA	2.94 mA dc	3.06 mA dc
	50 mA	49.47 mA dc	50.53 mA dc
	-400 mA	-404.3 mA dc	-395.7 mA dc
 DC Amps ^[1]	4.0 A	3.957 A dc	4.043 A dc
	-9.0 A	-9.12 A dc	-8.88 A dc

[1] Press to access this function.
[2] Does not include test lead resistance.

Table 4. Performance Tests 177/179

Test (Switch Position)	5500 Output	Product Response	
		Lower Limit	Upper Limit
\tilde{V} AC Volts	300 mV 45 Hz	296.7 mV ac	303.3 mV ac
	500 mV 500 Hz	494.7 mV ac	505.3 mV ac
	500 mV 1 kHz	489.7 mV ac	510.3 mV ac
	5 V 45 Hz	4.947 V ac	5.103 V ac
	5 V 500 Hz	4.947 V ac	5.053 V ac
	5 V 1 kHz	4.897 V ac	5.103 V ac
	50 V 45 Hz	49.47 V ac	50.53 V ac
	50 V 500 Hz	49.47 V ac	50.53 V ac
	50 V 1 kHz	48.97 V ac	51.03 V ac
	300 V 45 Hz	296.7 V ac	303.3 V ac
	500 V 500 Hz	494.7 V ac	505.3 V ac
	500 V 1 kHz	489.7 V ac	510.3 V ac
	1000 V 45 Hz	987 V ac	1013 V ac
	1000 V 500 Hz	987 V ac	1013 V ac
	1000 V 1 kHz	977 V ac	1023 V ac
\tilde{V} Hz AC Volts Frequency ^[1]	1 V 45 Hz	44.94 Hz	45.06 Hz
	1 V 900 Hz	899 Hz	901 Hz
	1 V 9 kHz	8.99 kHz	9.01 kHz
	5 V 50 kHz	49.94 kHz	50.06 kHz
\bar{V} DC Volts	5 V	4.993 V dc	5.007 V dc
	50 V	49.93 V dc	50.07 V dc
	300 V	299.5 V dc	300.5 V dc
	1000 V	997 V dc	1003 V dc
	-1000 V	-1003 V dc	-997 V dc
\bar{V} Hz DC Volts Frequency ^[1]	3 V 45 kHz	44.94 Hz	45.06 Hz
	30 V 50 kHz	49.94 kHz	50.06 kHz
\bar{mV} DC Millivolts	30 mV 0 Hz	29.8 mV dc	30.2 mV dc
	-300 mV	-300.5 mV dc	-299.5 mV dc
	600 mV	599.3 mV dc	600.7 mV dc

Table 4. Performance Tests 177/179 (continued)

Test (Switch Position)	5500 Output	Product Response	
		Lower Limit	Upper Limit
Ω Ohms ^[2]	500 Ω	495.3 Ω	504.7 Ω
	5 k Ω	4.954 k Ω	5.046 k Ω
	50 k Ω	49.54 k Ω	50.46 k Ω
	500 k Ω	495.4 k Ω	504.6 k Ω
	5 M Ω	4.954 M Ω	5.046 M Ω
	19 M Ω	18.68 M Ω	19.32 M Ω
 Capacitance ^[1]	Apply 0.90 μ F	887 nF	913 nF
	Apply 9 μ F	8.87 μ F	9.13 μ F
	Apply 90 μ F	88.7 μ F	91.3 μ F
	Apply 900 μ F	887 μ F	913 μ F
 Continuity	25 Ω	Beeper On	
	250 Ω	Beeper Off	
 Diode ^[1]	2.0 V	1.978 V dc	2.022 V dc
 AC Milliamps	3 mA 45 Hz	2.92 mA ac	3.08 mA ac
	50 mA 1 kHz	49.22 mA ac	50.78 mA ac
	400 mA 1 kHz	393.7 mA ac	406.3 mA ac
 AC Amps	4.0 A 45 Hz	3.937 A ac	4.063 A ac
	9.0 A 1 kHz	8.83 A ac	9.17 A ac
 DC Milliamp ^[1]	3 mA	2.94 mA dc	3.06 mA dc
	50 mA	49.47 mA dc	50.53 mA dc
	-400 mA	-404.3 mA dc	-395.7 mA dc
 DC Amps ^[1]	4.0 A	3.957 A dc	4.043 A dc
	-9.0 A	-9.12 A dc	-8.88 A dc
 Temperature ^{[1] [3] [4]} (179 only)	0 $^{\circ}$ C	-1.0 $^{\circ}$ C	1.0 $^{\circ}$ C
	-40 $^{\circ}$ C	-41.4 $^{\circ}$ C	-38.6 $^{\circ}$ C
	400 $^{\circ}$ C	395.0 $^{\circ}$ C	405.0 $^{\circ}$ C

[1] Press to access this function.

[2] Does not include test lead resistance.

[3] Be sure to use correct cable.

[4] To ensure accuracy, the Product and thermocouple adapter must be at the same temperature. Allow 20 minutes before performing the temperature procedures.

Calibration Adjustment

Perform the calibration adjustment procedures if the Product fails the performance test.

The Product buttons behave as follows when the calibration mode is enabled:

Press and hold to test the present function. This measurement is uncalibrated and may be inaccurate. This is normal.

Press and hold to display the required input.

Press to skip the present calibration step without accepting the input signal.

Note

If a calibration step is skipped, the remaining calibration procedure may be invalidated.

Note

This feature is not available for units with serial numbers 83911001 to 83911240 and 84060001 and above.

(YELLOW button) Press to store the calibration value and advance to the next step. This button is also used to exit calibration mode after the calibration adjustment sequence is complete.

Calibration Adjustment Procedure

Use the following steps to adjust the Product's calibration:

For Products with a serial number of 84060000 and below, switch the Product to volts **AC** (\widehat{V}). For Products with a serial number of 83911001 to 83911240 and 84060001 and above, switch the Product to **mV DC**.

1. Turn the Product over and find the Calibration Seal located near the top of the Product (see Table 5).
2. With a small probe, break the Calibration Seal and press the Calibration Button for 1 second. The Product will beep and change to the calibration mode. The display reads [\square], designating the first calibration step. The Product remains in calibration mode until the Rotary Function Switch is turned to **OFF**.
3. Proceed through the calibration steps by entering the input value listed in the table for each step.

Note

When calibrating or measuring AC current, avoid the potential for errors from coupled noise, by either:

1. *Shorting the $V\Omega\rightarrow$ to the **COM** input*
or
2. *Having NO connection to the $V\Omega\rightarrow$ input.*

Note

Press and wait until the step number advances before changing the calibrator source or turning the Rotary Function Knob.

4. After each input value is applied, press to accept the value and proceed to the next step ([\square] and so forth).
5. When the last step in a function is reached, turn the Rotary Function Knob to the next required function. The Product will not allow a step to be completed if the Rotary Function Knob is turned to the wrong function.

Note

If the calibration adjustment procedure is not completed correctly, the Product will not operate correctly. When calibration adjustment is not performed correctly, the Product displays the messages [RL] and Err and the Product must be recalibrated.

The Product is damaged and requires service if:

- **Err** and **Err** messages continue to appear after a proper recalibration.
- **Err** and **Err** messages are alternating on the display.
- **Err** message appears on the display.

Table 5. Calibration Steps

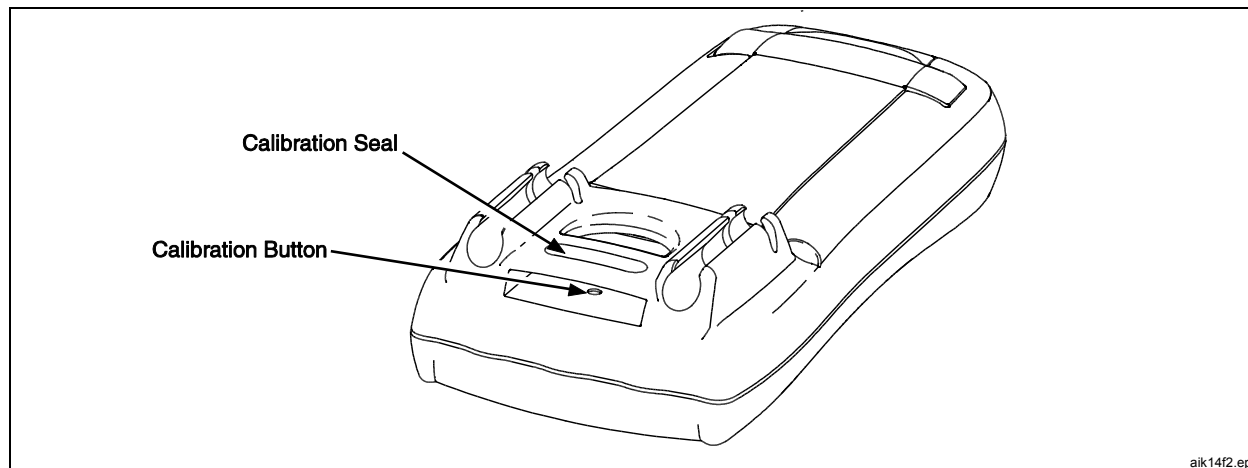

aik14f2.eps

If the Product has a serial number of 84060000 or below, or 83911241 to 84060000, use the following steps.

Function (Switch Position)	Calibration Step	Input Value
\tilde{V} (AC Volts)	C-01	6.000 V, 900.0 Hz
	C-02	600.0 mV, 100 Hz
	C-03	6.000 V, 100 Hz
\bar{V} (DC Volts)	C-04	6.000 V dc
	C-05	60.00 V dc
	C-06	600.0 V dc
	C-07	1000 V dc
\bar{mV} DC Millivolts (Temperature - 179 only) ^[1]	C-08	600.0 mV dc
	C-09	0.0 °C
Ω (Ohms)	C-09 (175/177)	6.000 k Ω
	C-10 (179)	
 (Continuity)	C-10 (175/177)	600 Ω
	C-11 (179)	
mA (Milliamps)	C-11 (175/177)	600.0 mA dc
	C-12 (179)	
A (Amps)	C-12 (175/177)	6.000 A dc
	C-13 (179)	

[1] To ensure accuracy, the Product and Thermocouple Adapter must be at the same temperature. Allow 20 minutes before performing the temperature procedures.

Table 5. Calibration Steps (continued)

If the Product has a serial number from 83911001 to 83911240 or 84060001 and above, or if the model number flashes on the display at turn on, use the following steps. ^[2]		
Function (Switch Position)	Calibration Step	Input Value
$\overline{\text{mV}}$ (DC Millivolts)	C-01	600.0 mV dc
	C-02	120.0 mV dc
$\overline{\text{V}}$ (DC Volts)	C-03	6.000 V dc
	C-04	60.00 V dc
	C-05	600.0 V dc
$\tilde{\text{V}}$ (AC Volts)	C-06	600.0 mV, 60 Hz
	C-07	600.0 V, 60 Hz
Ω (Ohms)	C-08	600.0 Ω
	C-09	6.000 k Ω
	C-10	60.00 k Ω
	C-11	600.0 k Ω
	C-12	6.000 M Ω
$\rightarrow +$ (Diode Test)	C-13	5.000 V dc
mA (Milliamps)	C-14	400.0 mA dc
	C-15	400.0 mA ac, 60 Hz
A (Amps)	C-16	6.000 A dc
	C-17	6.000 A ac, 60 Hz

[2] If the Product is not connected correctly, or if the rotary switch is in the wrong position, the Product will beep 2 times to alert the user.

User-Replaceable Parts and Accessories

User-replaceable parts and accessories are shown in Table 6 and Figure 4.

Table 6. User-Replaceable Parts and Accessories

Item	Description	Part No	Qty
--	TL75 Test Lead Set (Not shown) ^[1]	855705	1
①	Case Top (Model 175)	1591675	1
	Case Top (Model 177)	1589129	1
	Case Top (Model 179)	1589118	1
②	Shock Absorber	428441	1
③	Keypad (177, 179)	1560052	1
	Keypad (175)	1560842	1
④	LCD Mask (175)	1587908	1
	LCD Mask (177)	1587896	1
	LCD Mask (179)	1587881	1
⑤	LCD	1560856	1
⑥	LCD Light Pipe (177 & 179)	1564806	1
⑦	⚠ Fuse, 11 A, (fast acting), 1000 V ac/dc, minimum interrupt rating 17 kA ^[2]	803293	1
⑧	⚠ Fuse, 440 mA (fast acting), 1000 V ac/dc, minimum interrupt rating 10 kA ^[2]	943121	1
⑨	PCA Screw	519116	1
⑩	Shield, AC	648755	1
⑪	AC Shield screw and Internal Cover screws	448456	5
⑫	Case Bottom serial numbers 83911001 to 83911240 and 84060001 and above (includes Bottom Shield and Calibration Button, Beeper not included)	2095692	1
⑬	Battery, 9 V (Alkaline, 9 V, 0-200 mA)	614487	1
⑭	Battery Compartment Door	1564799	1
⑮	Case Screws	832246	4
⑯	Tilt Stand	648961	1
⑰	LCD Elastomeric Connector	650264	2
⑱	Internal Cover	1564786	1
⑲	Battery Connector, serial number 8391100 and below, and 83911241 to 84060000	825976	1
⑳	Battery Connector, serial numbers 8391101 to 83911240 and 84060001 and above	1988201	1
㉑	Beeper, serial numbers 8391101 to 83911240 and 84060001 and above	2041050	1
㉒	Switch Detent Spring	822643	1
㉓	Switch Knob	648706	1
㉔	Calibration Button	1564889	1
㉕	Lens	648714	1

[1] Fluke accessories are available from your authorized Fluke distributor.

[2] ⚠ To avoid shock, injury, or damage to the Product, use exact replacement only.

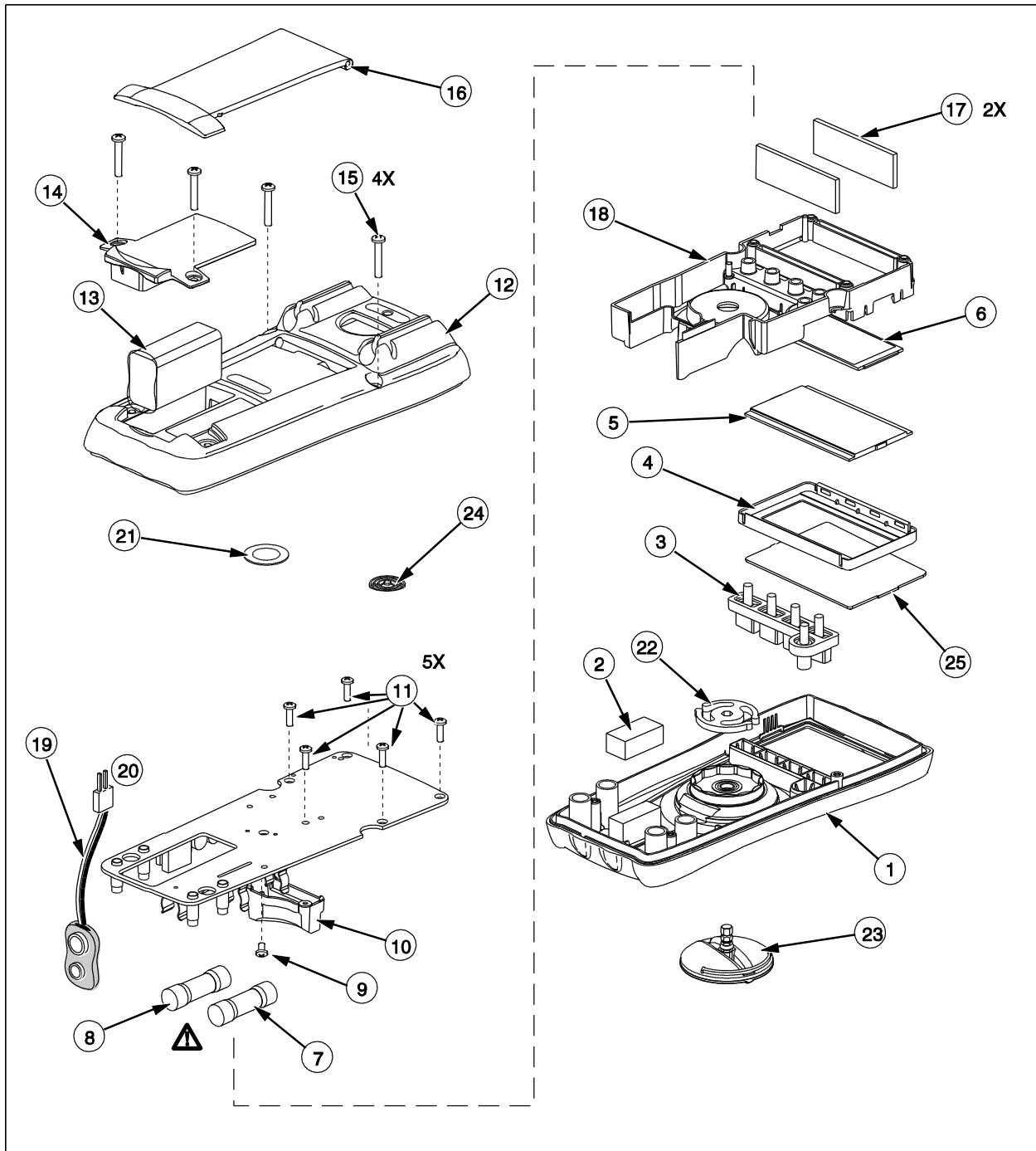

Figure 4. User-Replaceable Parts and Accessories

aik16f.eps

Lifetime Limited Warranty

Each Fluke 20, 70, 80, 170 and 180 Series DMM will be free from defects in material and workmanship for its lifetime. As used herein, "lifetime" is defined as seven years after Fluke discontinues manufacturing the product, but the warranty period shall be at least ten years from the date of purchase. This warranty does not cover fuses, disposable batteries, damage from neglect, misuse, contamination, alteration, accident or abnormal conditions of operation or handling, including failures caused by use outside of the product's specifications, or normal wear and tear of mechanical components. This warranty covers the original purchaser only and is not transferable.

For ten years from the date of purchase, this warranty also covers the LCD. Thereafter, for the lifetime of the DMM, Fluke will replace the LCD for a fee based on then current component acquisition costs.

To establish original ownership and prove date of purchase, please complete and return the registration card accompanying the product, or register your product on <http://www.fluke.com>. Fluke will, at its option, repair at no charge, replace or refund the purchase price of a defective product purchased through a Fluke authorized sales outlet and at the applicable international price. Fluke reserves the right to charge for importation costs of repair/replacement parts if the product purchased in one country is sent for repair elsewhere.

If the product is defective, contact your nearest Fluke authorized service center to obtain return authorization information, then send the product to that service center, with a description of the difficulty, postage and insurance prepaid (FOB Destination). Fluke assumes no risk for damage in transit. Fluke will pay return transportation for product repaired or replaced in-warranty. Before making any non-warranty repair, Fluke will estimate cost and obtain authorization, then invoice you for repair and return transportation.

THIS WARRANTY IS YOUR ONLY REMEDY. NO OTHER WARRANTIES, SUCH AS FITNESS FOR A PARTICULAR PURPOSE, ARE EXPRESSED OR IMPLIED. FLUKE SHALL NOT BE LIABLE FOR ANY SPECIAL, INDIRECT, INCIDENTAL OR CONSEQUENTIAL DAMAGES OR LOSSES, INCLUDING LOSS OF DATA, ARISING FROM ANY CAUSE OR THEORY. AUTHORIZED RESELLERS ARE NOT AUTHORIZED TO EXTEND ANY DIFFERENT WARRANTY ON FLUKE'S BEHALF. Since some states do not allow the exclusion or limitation of an implied warranty or of incidental or consequential damages, this limitation of liability may not apply to you. If any provision of this warranty is held invalid or unenforceable by a court or other decision-maker of competent jurisdiction, such holding will not affect the validity or enforceability of any other provision.

Fluke Corporation
P.O. Box 9090
Everett, WA 98206-9090
U.S.A.

Fluke Europe B.V.
P.O. Box 1186
5602 BD Eindhoven
The Netherlands